

MORE

mobile & internet & more

eero Max 7

Quick Start Guide



eero

eero

This guide provides instructions for setting up, connecting, and configuring your eero Max 7.

Contents:

Get to know your eero Max 7	3
How to set up your eero Max 7	5
eero Secure	8
How to connect your smart devices to your eero Max 7 network	10
How to create custom settings for people on your eero Max 7 network	11
Other important information about your eero Max 7	12
Need support?	12

Get to know your eero Max 7

The eero Max 7 provides premium Wi-Fi performance and speeds up to a 9.4Gbps (if you have an internet plan capable of supporting this speed)¹. The eero Max 7 features include:

- Wi-Fi 7 coverage up to 230 square metres per eero Max 7.
- Smart technology to reduce drop-offs and provide fast, reliable Wi-Fi.
- Built-in Zigbee Smart Home Hub can connect multiple devices on your network and includes support for Matter and Tread.
- World-class encryption, security protocols and ongoing security updates to help ensure your network stays safe and secure.
- Supports 200+ connected devices simultaneously.
- Easy system expansion with cross compatible hardware.
- Simple, app controlled setup with the eero mobile app which guides users through setup and device placement.

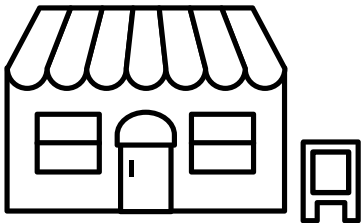

1 x eero Max 7 device provides up to 230sqm in coverage

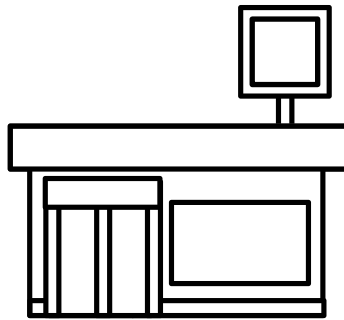

2 x eero Max 7 device provides up to 460sqm in coverage

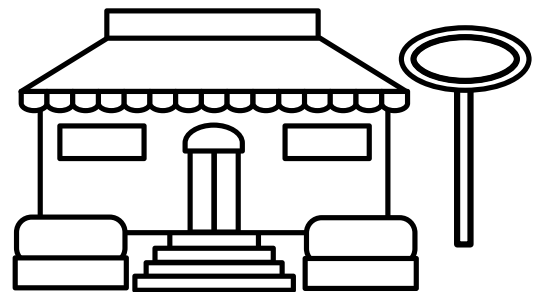

3x eero Max 7 device provides up to 690sqm in coverage

¹ Internet connection speeds and availability depend on the speed of the internet plan you have with More. If your internet plan does not provide you with the maximum supported speed achievable with your eero device, you will not experience that maximum speed. Maximum network speeds, if applicable, reflect combined supported speeds across wired and wireless clients. Maximum wireless signal rates are derived from IEEE 802.11 standard. Specifications assume wired Ethernet connection; your experienced speed may vary when connected to an eero device that is configured as a wireless extender. Eero devices are only compatible for use with FTTC, FTTP, HFC and Fixed Wireless internet access technologies. Coverage estimates are based on normal use conditions. Actual range and performance can vary, and maximum supported speeds may not be available to all customers, due to factors such as local regulations (including power limits), network configuration, interference, connected devices, device usage, building materials, and obstructions. Specifications are based on use of a Wi-Fi 6 or later generation client device. See <https://eero.com/legal> for more details regarding terms for eero products, software and services. For more information about eero performance, visit support.eero.com

Front view of the device



LED Light

Will indicate connection with a solid blue light.



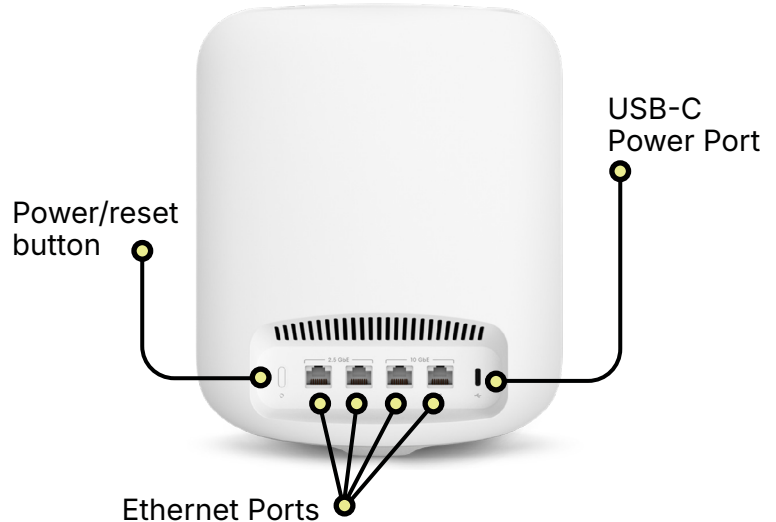





Back view of the device



Ethernet Ports



Connect your ethernet based devices, e.g. desktop computer, laptop and/or modem.

If your LED is in a different state, including a different colour or is blinking/flashing, please refer to the list below:



LED Colour	What it Means
 No Light	eero doesn't have power
 Blinking White	eero software starting up/connecting to the internet
 Blinking Blue	Broadcasting bluetooth
 Solid Blue	The eero app is connected to your eero and setting it up
 Blinking Green	Multiple eeros detected
 Blinking Yellow	Unapproved USB-C power source used
 Solid White	eero connected to the internet
 Solid Red	eero is not connected to the internet

How to set up your eero Max 7

Before you start to set up your eero Max 7 and network you will need the following:

- An iOS or Android device with a data connection.
- The eero app available from the [App Store](#)  or [Google Play Store](#) 
- A modem or device with an active connection to a More internet service.
- An email address.
- An active mobile phone number.

1. Download the eero app and create an account

Download the eero mobile app from the [App Store](#)  or [Google Play Store](#)  and create an account using your mobile number, email address or your existing Amazon account.

2. Unplug your nbn® connection box

Unplug all devices (including your old router) from your nbn® connection box and then unplug your box from power.

3. Connect your eero Max 7

Using the supplied ethernet cable, connect your eero to your nbn® connection box from one of the ethernet ports.

IMPORTANT: How you connect your eero Max 7 is dependent on your internet technology type. If you are unsure what nbn® technology type you have at your address, please check your nbn® order email from More.

Fibre to the Premises (FTTP) & Fixed Wireless

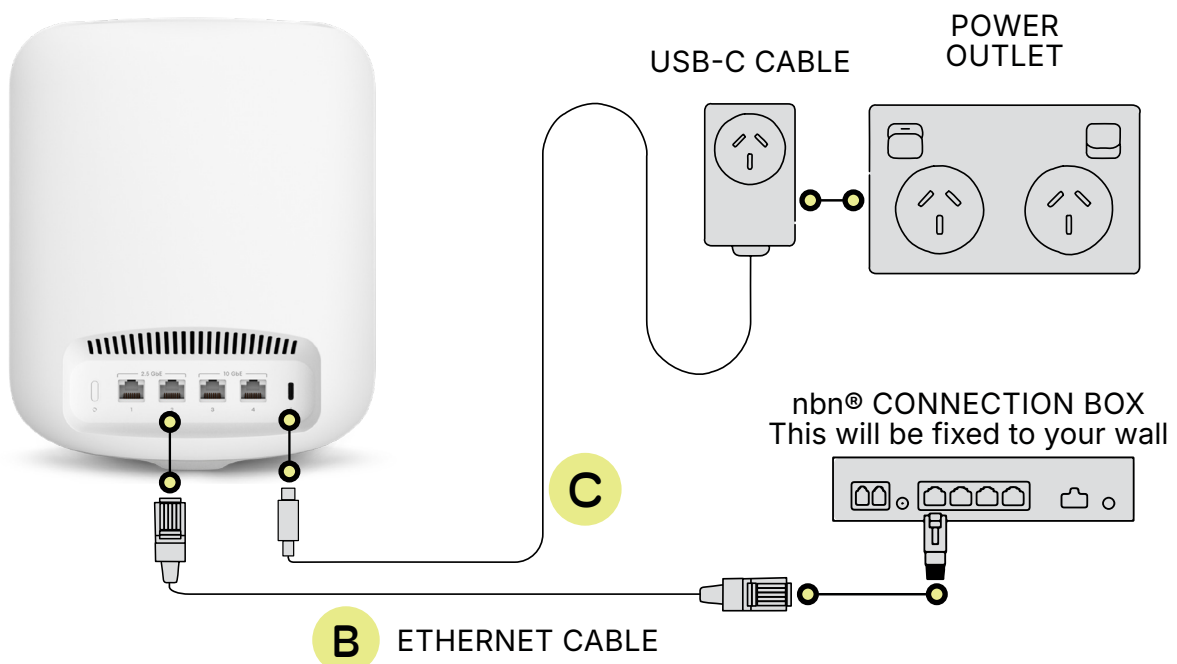

IMPORTANT: You will need to plug the ethernet cable from your eero Max 7 into your Network Termination Device's activated Uni-D port. If you are unsure which port has been activated, check your nbn® Ready to Go email from us.

Fibre to the Curb (FTTC) & Hybrid Fibre Coaxial (HFC)

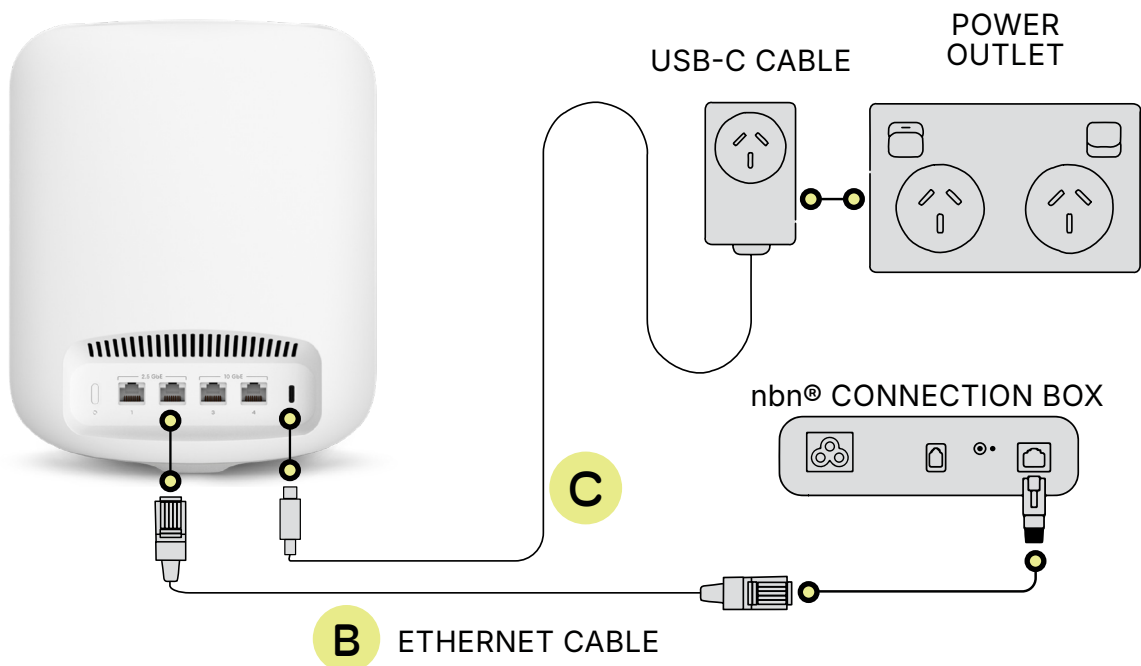

4. Plug your eero Max 7 to power

Plug your eero and nbn® connection box to an available power outlet. For optimal performance you should:

- Place your eero device(s) on a hard, flat surface that's not closed in. Try to avoid placing it inside a media console or cabinet, behind or underneath any large furniture.
- Avoid placing your eero device(s) in front, on top of or under any electronics or appliances e.g. fridge, microwave, etc., as metal objects can block wifi signals

5. Check your status light

The status light on your eero will begin flashing white as it searches for your device, and then turn solid white once it finds it.

Note: If your eero light is in any other state or colour, refer to the table on page 4.

If you have additional eero devices:

Select the 'Add another eero device' button on your screen and plug your additional eero to power. If you have a third eero device to add to your network, follow the same steps otherwise select the 'Finish setup' button.

eero Secure

How to apply eero Secure content filters.

eero Secure's content filters allow users to apply pre-set content filters by age range or customise by category, including adult content, illegal or criminal, violent, social media, streaming, chat or messaging, games, shopping, SafeSearch, and YouTube Restricted Mode.

To apply content filters:

- From the 'Home' tab, tap the profile to which you want to apply content filters.
- Select 'Content Filters'.
- Tap the desired filter template and tap 'Apply'

How to set up eero Secure internet backup.

eero Secure's Internet backup² lets users add alternate wireless backup connections, such as their personal hotspot, to keep their Wi-Fi up and running during an nbn[®] or modem outage. When the internet goes down, users can temporarily switch their eero network over to their backup source to broadcast Wi-Fi throughout their business, so their connected devices stay online.

To set up an internet backup:

- From the 'Home' tab in the eero mobile app, tap on 'Internet' and select 'eero Internet Backup'.
- Toggle on 'eero Internet Backup' to turn on.

- Click on 'Add a network'.
- Select your network from the list and enter your password.
- Tap 'Done'.

²Access of this feature requires customers to have a compatible backup internet connection and a current eero Secure subscription. Use of this feature does not guarantee zero disruption to internet connection and is not suitable if you require uninterrupted internet connection. You are responsible for any data charges and/or other charges that may result due to use of a backup internet in conjunction with this feature. If your backup internet has a limited amount of included data (e.g. you are using mobile hotspot) and you use all of this data, eero Internet Backup may not work. The backup internet connection speeds and availability are dependent upon the backup internet provider and may vary due to factors such as concurrent users, obstructions, building materials, location and local conditions. Access to backup internet connection may require backup power in instances of power outage.

How to turn on eero Secure advanced security.

eero Secure's advanced security feature helps keep users safe from accidentally visiting malicious sites that may infect your devices³.

To turn on advanced security:

- From the 'Discover' tab, tap 'eero Secure'.
- Scroll down to the network section.
- Toggle on 'Advanced Security'

³Access to this feature requires customers to have a current eero Secure subscription. The eero Secure Advanced Security feature is intended for personal use only and is not suitable as a comprehensive security solution for businesses.

How to block websites with eero Secure.

eero Secure's Block & Allow feature gives users control over which sites can be visited by other users on their network and what content can be viewed.

- From the 'Home' tab, tap the profile to which you want to apply site blocks.
- Select 'Block & allow sites'.
- Tap 'Add Blocked Site'.
- Enter the URL of the website you wish to block.
- Confirm selection by tapping 'Done'.

How to block apps with eero Secure

eero Secure gives users the ability to block other users' access to apps as well as allow access to apps that may otherwise be blocked by content filters.

To block apps:

- From the 'Home' tab, tap the profile to which you want to apply app blocks.
- Select 'Block apps'.
- Select the apps that you want to block.
- Confirm selection by tapping 'Done'.

How to block ads with eero Secure

eero Secure's ad-blocking feature helps you improve your browsing experience by blocking a variety of ads on your devices.

To block ads:

- From the 'Discover' tab, tap 'eero Secure'.
- Scroll down to the 'Network' section.
- Turn on 'Ad Blocking'.

How to connect your smart devices to your eero network.

You can connect compatible smart devices to your eero network once you have linked your eero account with your Amazon account. If you didn't link your accounts upon sign up, you can do so by:

- Logging into the eero app.
- Navigate to the Discover tab.
- Select 'Amazon Connected Home.'

- Tap 'Connect to Amazon' and login using your Amazon account.

Once your accounts are linked, your enabled devices will join the network almost instantly when plugged in and stay connected even when you change your network name or password through the Amazon Frustration-Free Setup.

How to create custom settings for people on your eero network.

You can set custom schedules, control internet access, and apply content filters by creating profiles through the eero mobile app.

- Select the 'Home' tab and tap on the + symbol in the top right corner of the screen.
- Select 'Add a Profile' from the pop-up menu.
- Add a profile name.
- Select which devices to add to a profile.
- Tap 'Done'.

How to customise profile settings:

- Select the 'Home' tab and tap the profile or device for which you want to set a schedule.
- Select 'Add a Scheduled Pause'.
- Update the schedule name, start time, end time, and frequency for the scheduled pause, then tap 'Save'.

Other important information about your eero Max 7

1 Year Manufacturer's Warranty

In addition to any rights or remedies you may have under the Australian Consumer Law, your eero device also comes with a 1-year limited manufacturer's warranty from the date of purchase that covers faults with eero devices purchased from More (subject to certain exclusions). Please see our Hardware Warranty Information on our [Policies](#) page for further information, including how you can contact us to submit a warranty claim.

eero Secure Subscription at no additional cost

When you purchase an eero device from More, we will provide you with an ongoing subscription to eero Secure at no additional cost for use with a compatible More internet service⁴. eero Secure protects your growing online life by helping to keep your family's personal information, connected devices, and network protected from online threats. eero Secure also gives you access to advanced parental controls, including content filters and the ability to block and allow individual sites to help keep your family safe from the content they're not ready for.

⁴ eero Secure subscriptions are subject to More's Standard Form of Agreement – Part I and other applicable policies available on our [Policies page](#).

Need support?

For further information on the eero Max 7 please refer to our [website](#).

For a more comprehensive user guide, you can view the eero Max 7 User Guide [here](#).

Alternatively, for Customer Service and troubleshooting, contact our team on **1800 733 368**