

MORE

mobile & internet & more

eero 6+

Quick Start Guide



eero

This guide provides instructions for setting up, connecting, and configuring your eero 6+.

Contents:

Get to know your eero 6+	3
How to set up your eero 6+ and network	5
How to connect your smart home devices to your eero 6+ network	8
How to create custom settings for people on your eero 6+ network	8
Other important information about your eero 6+	9
Need support?	10

Get to know your eero 6+

The eero 6+ provides premium Wi-Fi performance and speeds up to a gigabit (if you have an internet plan capable of supporting this speed),* all without the premium price tag. The eero 6+ features include:

- Whole-home Wi-Fi 6 coverage up to 140 square metres per eero 6+.
- Smart technology to reduce drop-offs and provide fast, reliable Wi-Fi.
- Entertainment-ready Wi-Fi to download 4K content, stream music and play online games in confidence.
- Smart home hub functionality to control Thread and Zigbee devices (account linking required).
- Simple, app controlled and guided set up to connect devices and create a wireless mesh network.
- Supports 75+ connected devices simultaneously.
- Easy system expansion with cross compatible hardware.
- Ongoing software updates to help keep your network and data safe and secure.

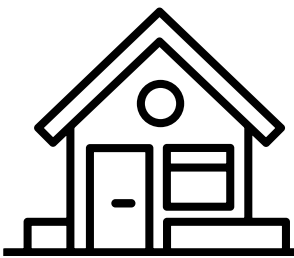

Standard Homes

(1-2 bedrooms) up to 140 m²

1 x **eero 6+** device is suitable



Medium Homes

(3-4 bedrooms) up to 280 m²

2 x **eero 6+** devices are suitable

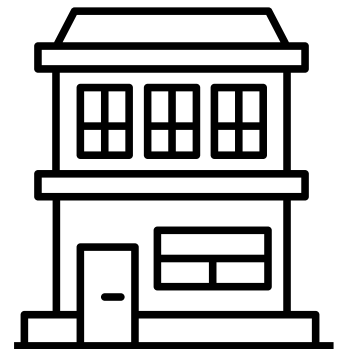

Large Homes

(5-6 bedrooms) up to 420 m²

3 x **eero 6+** devices are suitable

Front view of the device



LED Light

Will indicate connection with a solid blue light.



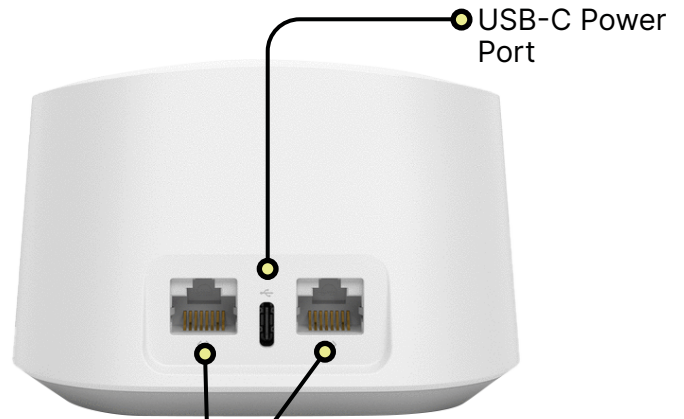





Back view of the device



Ethernet Ports



Connect your ethernet based devices, e.g. desktop computer, laptop and/or modem.

If your LED is in a different state, including a different colour or is blinking/flashing, please refer to the list below:

LED Colour	What it Means
 No Light	eero doesn't have power
 Blinking White	eero software starting up/connecting to the internet
 Blinking Blue	Broadcasting bluetooth
 Solid Blue	The eero app is connected to your eero and setting it up
 Blinking Green	Multiple eeros detected
 Blinking Yellow	Unapproved USB-C power source used
 Solid White	eero connected to the internet
 Solid Red	eero is not connected to the internet

How to set up your eero 6+

Before you start to set up your eero 6+ and network you will need the following:

- An iOS or Android device with a data connection.
- The eero app available from the App Store  or Google Play Store 
- A modem or device with an active connection to a More internet service.
- An email address.
- An active mobile phone number.

1. Download the eero app

from the App Store  or Google Play Store 

2. Create an eero account

You can sign up to eero using your phone number, email address or existing Amazon account.

3. Connect your eero 6+

1. Unplug your nbn® connection box from power and ensure that there are no other devices connected to it.
2. Connect your eero 6+ to your nbn® connection box from either of the ethernet ports using the ethernet cable supplied with your eero 6+.
3. Plug your eero 6+ and nbn® connection box to an available power outlet.

IMPORTANT: How you connect your eero 6+ is dependent on your internet technology type. If you are unsure what nbn® technology type you have at your address, please check your nbn® order email from More.

Fibre to the Premises (FTTP) & Fixed Wireless

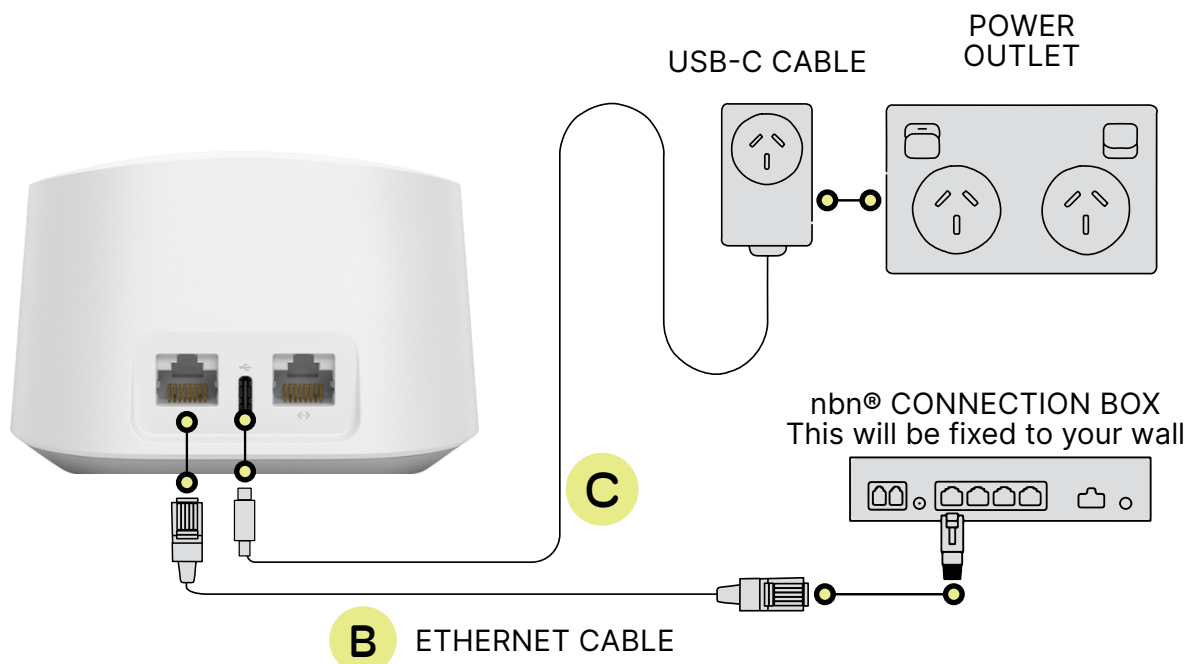

IMPORTANT: You will need to plug the ethernet cable from your eero 6+ into your Network Termination Device's activated Uni-D port. If you are unsure which port has been activated, check your nbn® Ready to Go email from us.

Fibre to the Curb (FTTC) & Hybrid Fibre Coaxial (HFC)

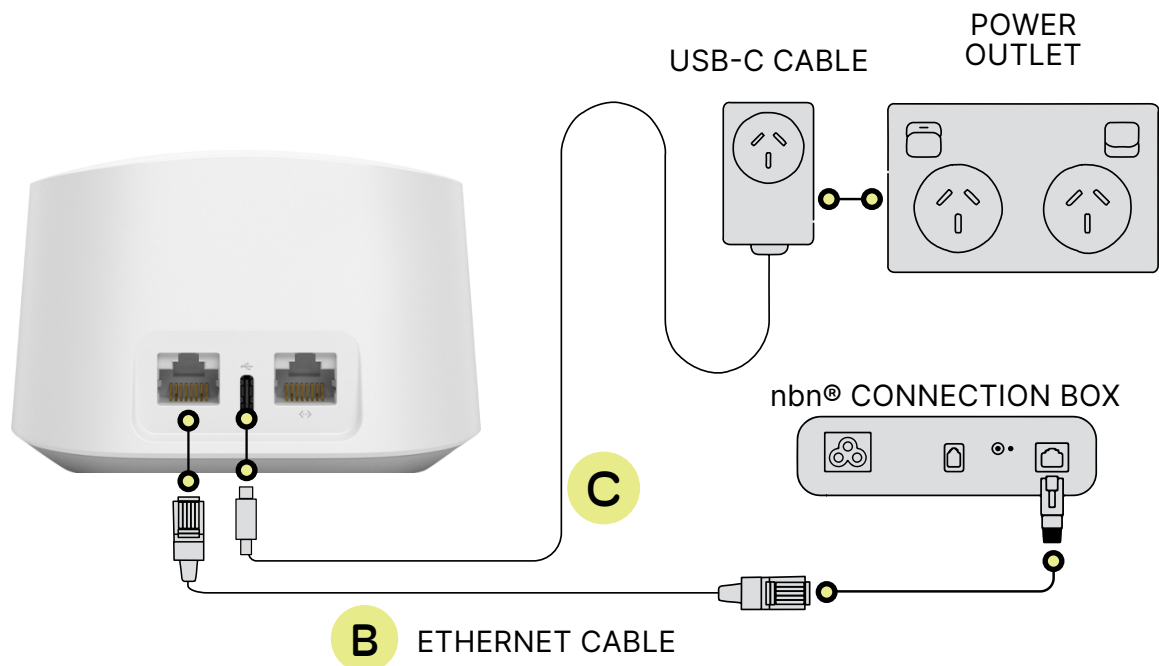

4. Create your eero 6+ network

- After pressing next in the eero app, it will begin to look for your eero 6+. The router will begin to flash blue and then present a solid blue light once detected.
- Select a location for your eero 6+ in the app and then set your own network name and network password, this is how other devices will join your network. Click next to complete set up.

5. Add eero 6+ device to expand your network

When adding your eero device to your network please keep in mind the following placement tips:

- If you have a dead spot, try to place your new eero device between the dead spot and another eero device to ensure a strong connection.
- Try not to place your eero device inside a media console or cabinet, behind or underneath any large furniture.
- Avoid placing your eero 6+ device in front, on top of or under any electronics or appliances as metal objects can block Wi-Fi signals.

Now that your eero network is set up you're free to do all the things you love online like stream music, read, and play video games!

How to connect your smart home devices to your eero 6+ network

You can connect your smart home devices to your eero network once you have linked your eero account with your Amazon account. If you didn't link your accounts upon sign up, you can do so by:

- Logging into the eero app.
- Navigate to the Discover tab.
- Select 'Amazon Connected Home.'
- Tap 'Connect to Amazon' and login using your Amazon account.

Once your accounts are linked, your enabled devices will join the network almost instantly when plugged in and stay connected even when you change your network name or password through the Amazon Frustration-Free Setup.

How to create custom settings for people on your eero 6+ network

You can set custom schedules, control internet access, and apply content filters by creating profiles through the eero mobile app.

- Select the 'Home' tab and tap on the + symbol in the top right corner of the screen.
- Select 'Add a Profile' from the pop-up menu.
- Add a profile name.
- Select which devices to add to a profile.
- Tap 'Done'.

How to customise profile settings:

- Select the 'Home' tab and tap the profile or device for which you want to set a schedule.
- Select 'Add a Scheduled Pause'.
- Update the schedule name, start time, end time, and frequency for the scheduled pause, then tap 'Save'.

Other important information about your eero 6+

1 Year Manufacturer's Warranty

In addition to any rights or remedies you may have under the Australian Consumer Law, your eero device also comes with a 1-year limited manufacturer's warranty from the date of purchase that covers faults with eero devices purchased from More (subject to certain exclusions). Please see our Hardware Warranty Information for further information, including how you can contact us to submit a warranty claim.

eero Secure Subscription at no additional cost

When you purchase an eero device from More, we will provide you with an ongoing subscription to eero Secure at no additional cost for use with a compatible More internet service.*

eero Secure protects your growing online life by helping to keep your family's personal information, connected devices, and network protected from online threats. eero Secure also gives you access to advanced parental controls, including content filters and the ability to block and allow individual sites to help keep your family safe from the content they're not ready for.

*eero Secure subscriptions are subject to More's Standard Form of Agreement – Part I and other applicable policies available on our [Policies page](#).

The features of eero Secure include (subject to change from time to time on provision of reasonable notice):

Feature	Description
eero Internet Backup	Connect your eero network to an alternate internet data hotspot to keep the network up and running during an outage.
Advanced Security	Advanced protection against online threats for all the devices on your network.
Block Ads	Block Ads to remove ads from websites and applications.
Block / Allow websites	Block access to individual websites and apps. Allow access to individual sites and apps that may otherwise be blocked by content filters.
Block apps	Block popular apps by profile.
SafeSearch	Rest assured that Google search results are appropriate using SafeSearch.
Content Filtering	Use Content Filtering to set profile-specific filters against different types of content.
Network Insights	See your historical network usage and eero performance data over time.

Need support?

For a more comprehensive user guide, you can view the eero 6+ User Guide [here](#).

Alternatively, for Customer Service and troubleshooting, contact our team on **1800 733 368**